

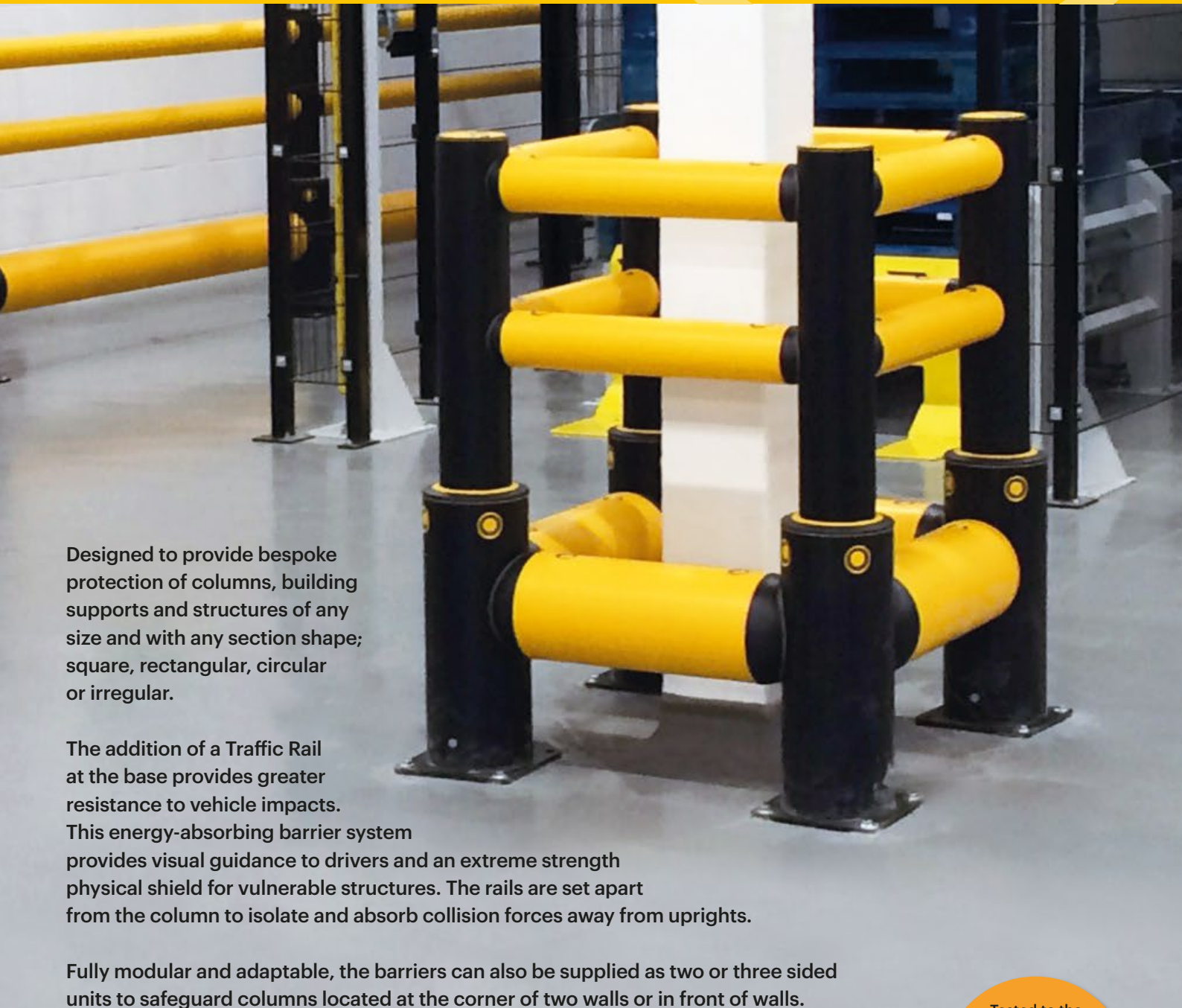

# iFlexRail™

## Column Guard+

# A-SAFE



Designed to provide bespoke protection of columns, building supports and structures of any size and with any section shape; square, rectangular, circular or irregular.

The addition of a Traffic Rail at the base provides greater resistance to vehicle impacts. This energy-absorbing barrier system provides visual guidance to drivers and an extreme strength physical shield for vulnerable structures. The rails are set apart from the column to isolate and absorb collision forces away from uprights.

Fully modular and adaptable, the barriers can also be supplied as two or three sided units to safeguard columns located at the corner of two walls or in front of walls.

Tested to the  
global benchmark  
in barrier safety

**bsi. PAS 13**  
Code of Practice for  
Workplace Safety  
Barriers

# Engineered for performance

**Memaplex™ advanced strength polymer** created from an exclusive composition of the most sophisticated polyolefins and rubber additives, expertly blended for unequalled strength and flexibility.

**Unrivalled recovery** through a unique built-in memory that allows the barrier to flex, cushion and reform repeatedly upon impact, saving vast amounts in barrier and vehicle repairs.

**Huge return on investment** from incident prevention and downtime avoidance as rails, vehicles, floors and infrastructure do not need replacing or repair.

**Self coloured and UV stabilised** for continued high visibility and long lasting aesthetics with no repainting.

**Ultra-low maintenance** material is chemical and water resistant, non-corrosive, non-scratch and self coloured so no repainting, rusting, flaking or corrosion.

**Energy absorption system** dissipates impact forces through the barrier and away from floors and fixings, preventing costly damage.

**Hygiene seals** remove ingress points.

**Multi-directional system** ensures a streamlined fit around any column shape and any column location.

**Zinc nickel, electrophoretic coating** on base plates as standard, provides advanced protection against corrosion damage.

## ADDITIONAL BASE OPTIONS



Countersunk Bolts

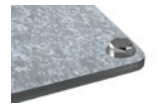

Galvanised Steel

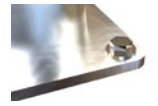

Stainless Steel 316 Standard

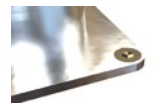

Stainless Steel 316 Countersunk

## Technical Information

Impact Test	Impact Angle on 1500mm Post Centres			
	90°	67.5°	45°	22.5°
Mid Rail Max Energy (Joules)	13,750	16,109	27,500	93,891

End Post Max Energy (Joules) - 90°	6,500
Mid Post Max Energy (Joules) - 90°	6,500

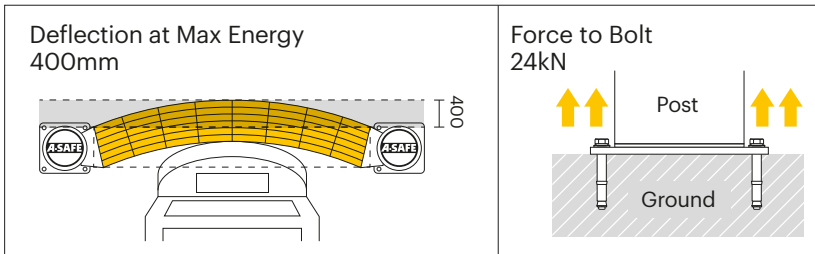

Material Properties	MEMAPLEX™
Temperature Range	-10°C to 50°C
Ignition Temperature	370°C to 390°C
Flash Point	350°C to 370°C
Toxicity	Not Hazardous
Chemical Resistance	Excellent - ISO/TR 10358
Weathering Stability (Grey Scale)	5/5*
Light Stability (Blue Wool Scale)	7/8**
Static Rating (Surface Resistivity)	1015 - 1016 Ω
Hygiene Seals	Yes

\* Weathering scale 1 is very poor and 5 is excellent

\*\* Light stability scale 1 is very poor and 8 is excellent

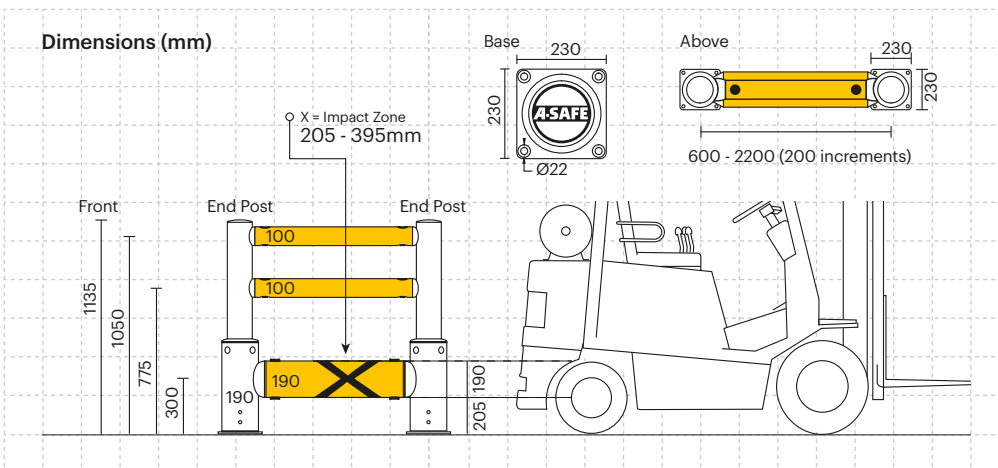

## Colour Combinations

### Post Options



### Rail Options

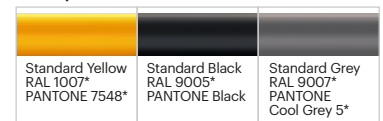

\*Please note that the RAL and PANTONE colours listed are the closest match to standard A-SAFE colours, but may not be exact matches of the actual product colour and should be used for guidance only.

